

- F Notice de montage ● GB Installation instructions
- E Manual de instalación ● I Istruzioni di montaggio
- NL Montage instructies ● D Montageanleitung

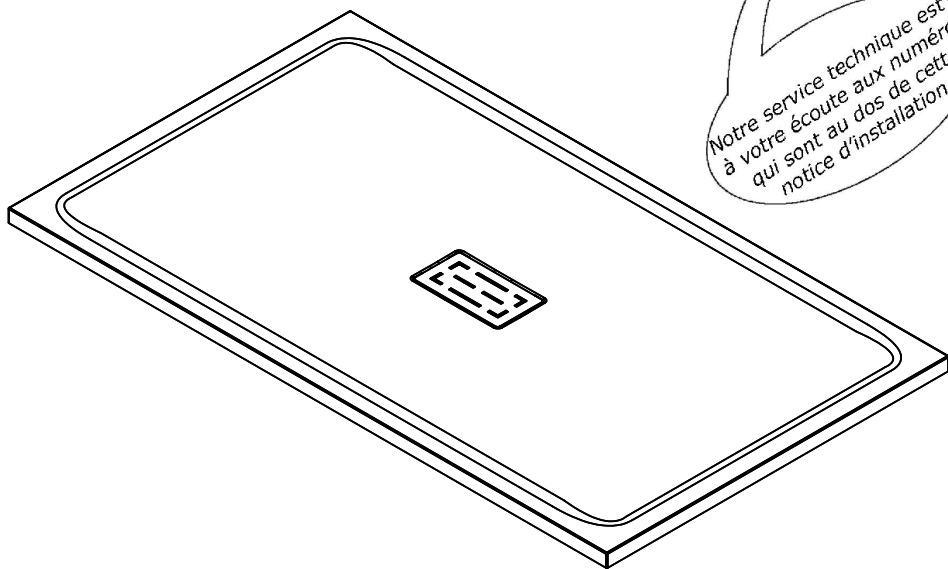

- F Attention aux étapes :
- GB Check installation steps :
- E Atención a los pasos :
- I Attenzione ai passi :
- NL Aandacht voor de stappen :
- D Achtung vor den Schritten :

P. 7 - 32 - 33

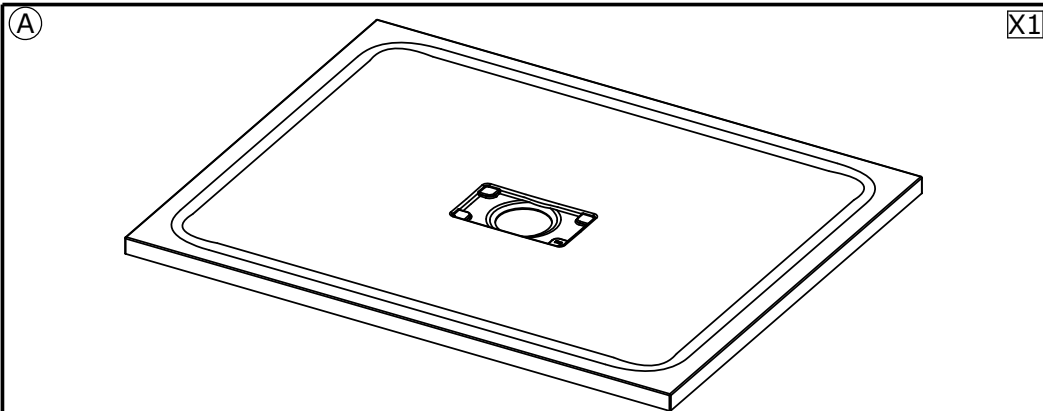

REC766	90X70	REC767	100X80	REC768	120X80	REC769	140X80
--------	-------	--------	--------	--------	--------	--------	--------

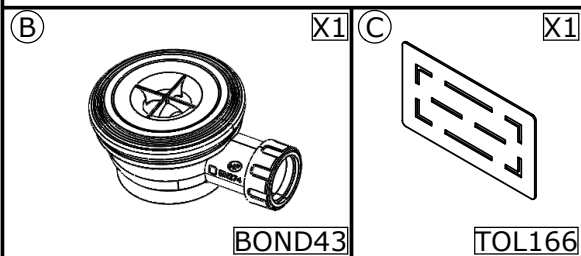

BOND43

TOL166

- Les quantités données sont les quantités utiles au montage. les sachets fournis contiennent des pièces supplémentaires.
- The quantities given are what are required for the installation. There may be some surplus in the package provide.
- Las cantidades indicadas son las cantidades necesarias para el montaje. Las bolsitas incluidas contienen piezas suplementarias.
- Le quantità fornite sono le quantità necessarie al montaggio. I sacchetti forniti contengono pezzi supplementari.
- De aangegeven aantallen zijn bestemd voor de montage. De bijgeleverde zakjes bevatten extra onderdelen
- Die Mengenangaben beziehen sich auf die für die Montage benötigten Teile. Es kann eine gewisse Überzahl an Teilen in der Packung vorhanden sein.

**F** Matériel nécessaire **GB** Tools required **E** Material necesario  
**I** Materiale necessario **NL** Benodigdheden **D** Erforderliche Werkzeuge

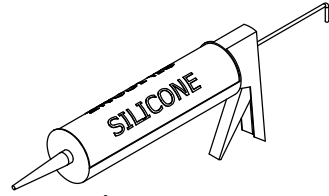
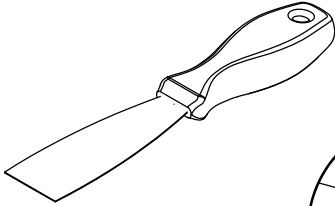
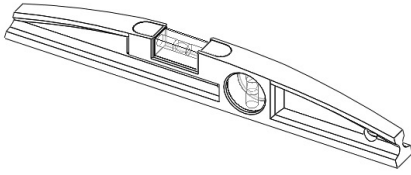

- F** Colle polyuréthane ou MS polymère
- GB** Polyurethane adhesive or MS polymer
- E** Pegamento poliuretano o polímero MS
- I** Colla poliuretanică o MS polimer
- NL** Polyurethaan of MS-polymeer lijm
- D** Polyurethan oder MS-Polymere Montagekleber verwenden

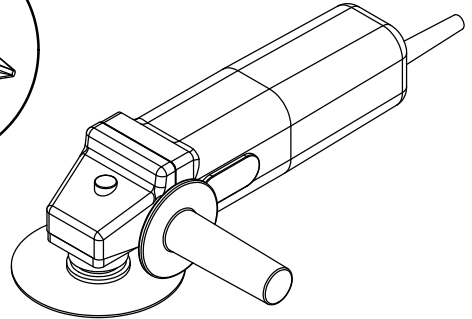
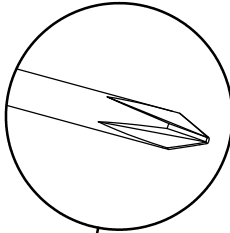
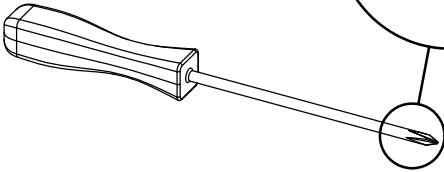

- F** Meuleuse avec lame diamant Ø230mm min.
- GB** Grinder with diamond blade Ø230mm min.
- E** Pulidora con disco diamantado Ø230mm min.
- I** Mola con lama diamantata Ø230mm min.
- NL** Diamantslijpschijf Ø230mm min.
- D** Winkelschleifer mit Diamanttrennscheibe Ø230mm min.



- DECOUPE OPTIONNELLE DU RECEVEUR
- ZONE AVAILABLE FOR OPTIONAL RECUTTING
- RECORTE OPCIONAL
- TAGLIO OPZIONALE DEL PIATTO
- ZAGEN VAN DE DOUCHEBAK, OPTINEEL
- OPTIONALE SCHNEIDBEREICHE DER DUSCHWANNE

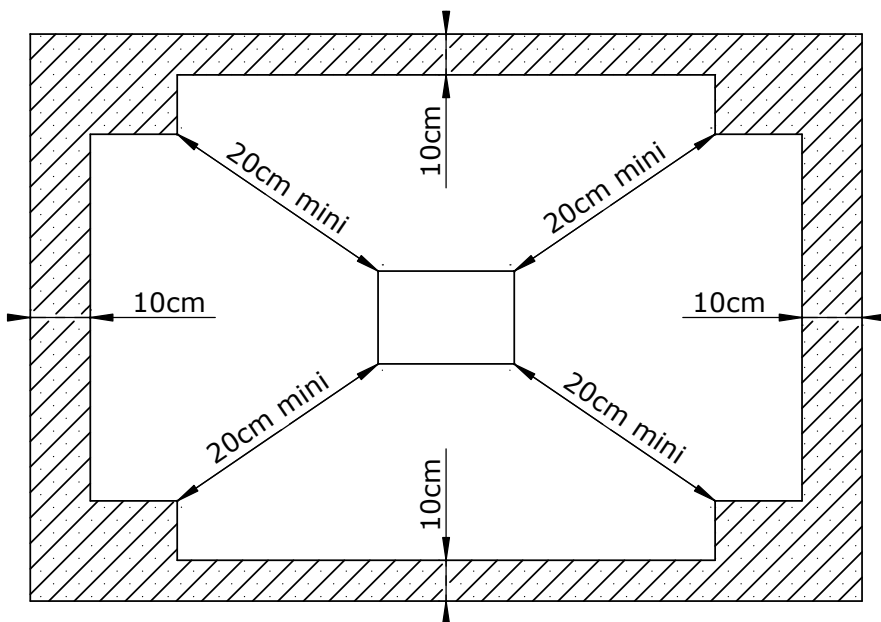

- Zone MAXI découpable
- MAX cuttable area
- Zone MAXIMA de recorte
- Limite MASSIMO di taglio
- MAXIMAAL aanpasbaar deel
- MAXIMALER Schneidbereich

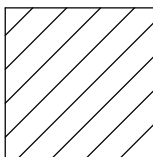



1

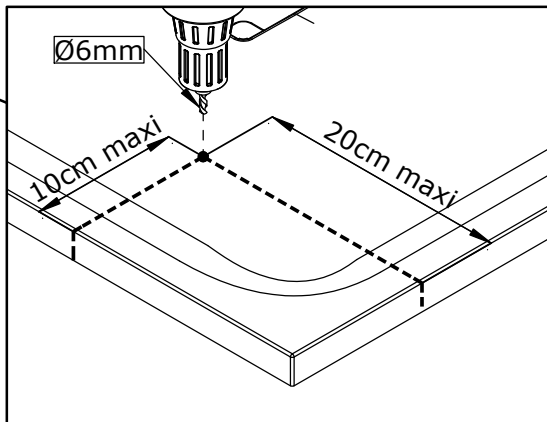
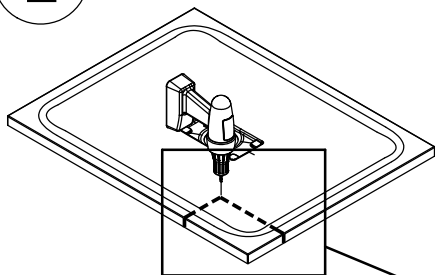

2

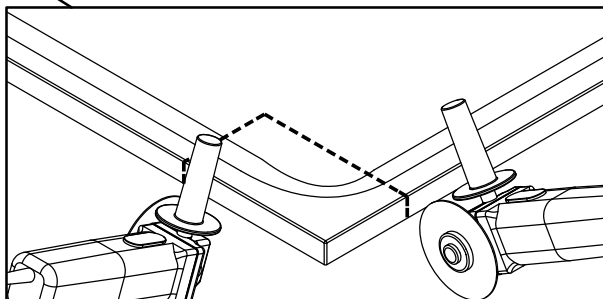
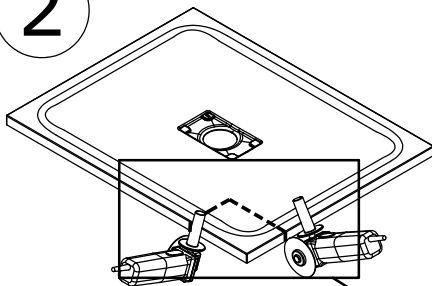

3



➊ - Appliquer une couche de colle polyuréthane ou MS polymère à l'aide d'une spatule sur la surface coupée et combler l'espace entre les nervures du receveur avec une couche de mortier adhésif.

➋ - Apply a polyurethan adhesive or MS polymer layer using a spatula over the raw surface and fill the space between the ribs of the tray with a layer of adhesive mortar.

➌ - Aplicar una capa de pegamento poliuretano o polímero MS en la superficie recortada. Puede ayudarse de una espátula y rellenar los espacios huecos del plato con una capa de mortero adhesivo.

➍ - Applicare della colla poliuretana o MS polimero con l'aiuto di una spatola sulla parte tagliato e compensare lo spazio tra le venature del piatto con uno strato di materiale adesivo.

➎ - Breng met een spatel een laag polyurethaan lijm of MS polymeer lijm aan op de zaagranden, en vul de tussenliggende ruimte tot het steunoppervlak van de douchebak op met een laag cement.

➏ - Wenn Sie ihre Duschtasse zuschneiden, müssen die Schnittkanten mittels Polyurethan- oder MS-Polymer-Klebstoff versiegelt werden. Tragen Sie die Versiegelung mit einem Spachtel auf der Schnittfläche bis unterhalb der Duschtasse auf.

- ➊ Colle polyuréthane/MS polymère
- ➋ Polyurethane adhesive/MS polymer
- ➌ Pegamento poliuretano/polimero MS
- ➍ Colla poliuretana/MS polimero
- ➎ Polyurethaan/MS polymeer lijm
- ➏ Schicht aus Polyurethan-/MS-Polymer-Klebstoff

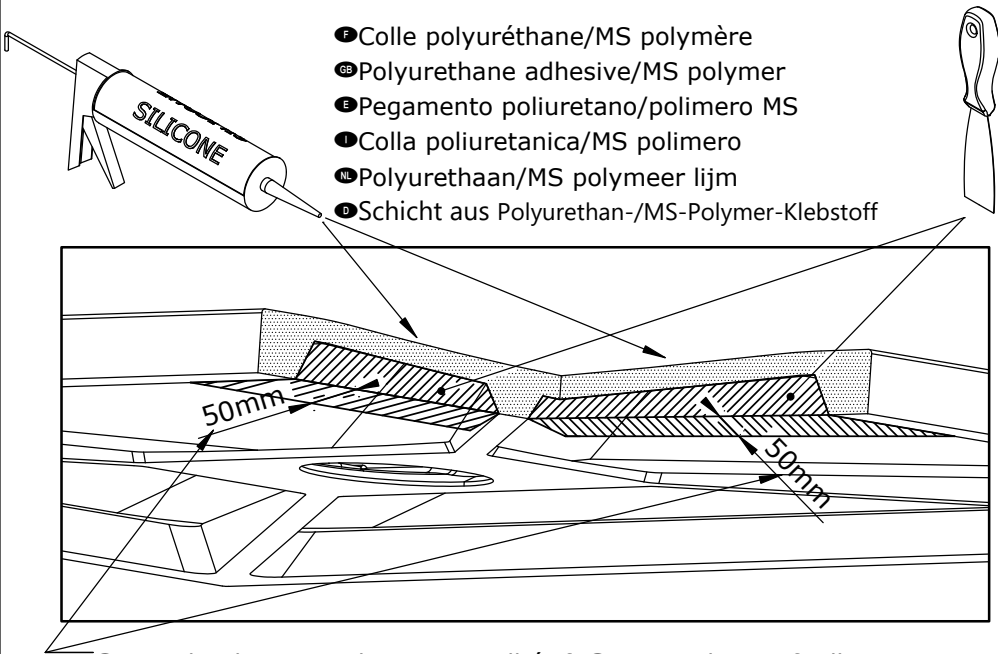

- ➊ Couche de 50mm de mortier adhésif
- ➋ 50mm layer of adhesive mortar
- ➌ Capa de 50mm de grosor de mortero adhesivo
- ➍ Strato di 50mm di materiale adesivo
- ➎ Laag van 50mm lijm mortel
- ➏ 50 mm Versiegelung auftragen

- F Nombre de pieds ● GB Feet quantity ● E Cantidad de pies  
 ● I Quantità di piedini ● NL Hoeveelheid voeten ● D Anzahl an Füße

<b>REC766</b>	90X70	<b>REC767</b>	100X80	<b>REC768</b>	120X80	<b>REC769</b>	140X80
---------------	-------	---------------	--------	---------------	--------	---------------	--------

● La distance bord à bord entre deux pieds ne doit pas être de plus de 30 cm.  
LES PIEDS DOIVENT ETRE INSTALLES SUR LES NERVURES DU RECEVEUR.

● The distance from the edge of the shower tray to the edge of a peripheral support should be no more than 30 cm.  
THE FEET MUST BE INSTALLED ON THE SHOWER TRAY RIBS.

● La distancia entre cada pie no debe superar los 30 cm.  
LOS PIES DEBEN ESTAR INSTALADOS SIGUIENDO LAS NERVIOS DEL PLATO.

● La distanza tra due piedi non dovrebbe essere superiore a 30 cm.  
I PIEDI DEVONO ESSERE INSTALLATI SULLE NERVATURE DEL PIATTO DOCCIA.

● De afstand tussen twee stelpoten mag niet meer dan 30 cm bedragen.  
DE STELPOTEN DIENEN OP HET STEUNOPPERVLAK VAN DE DOUCHEBAK GEÏNSTALLEERD TE WORDEN.

● Der Abstand zwischen zwei verstellbaren Füßen darf 30 cm nicht überschreiten.  
DIE FÜßE MÜSSEN AUF DEN TRÄGERN DER DUSCHTASSE MONTIERT WERDEN.

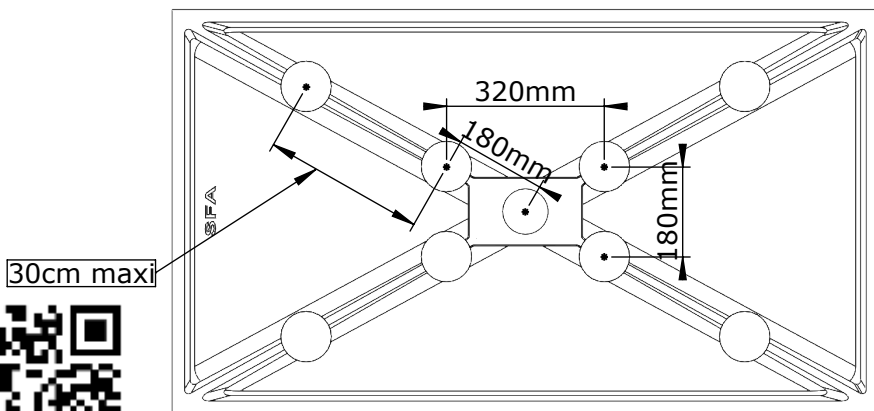

[http://tiny.cc/notice\\_pieds\\_universelle](http://tiny.cc/notice_pieds_universelle)

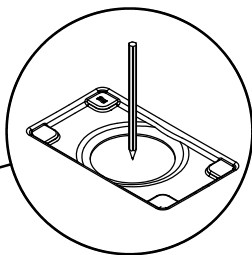
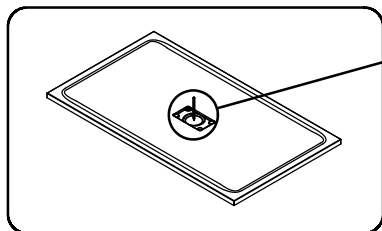
**F**

Tracer la position de la bonde et réaliser un montage à blanc de la bonde et du receveur

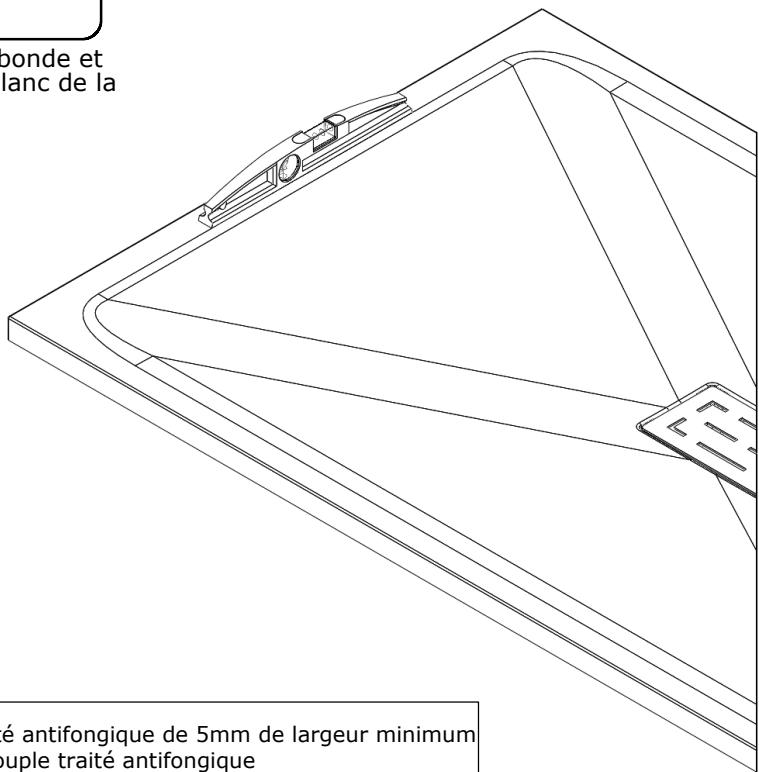

- ① - silicone de finition traité antifongique de 5mm de largeur minimum
- ② - silicone d'étanchéité souple traité antifongique
- ③ - élément de soutien du joint silicone
- ④ - silicone d'appui
- ⑤ - colle polyuréthane ou MS polymère

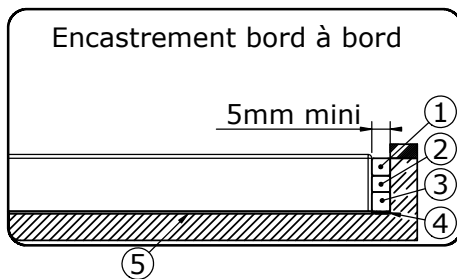
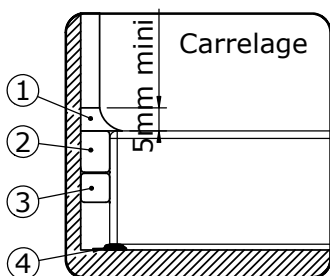



Pendant toute la durée des travaux, protéger le receveur contre toute agression : brûlures, chocs, rayures, décapants...



Le montage d'une soupape anti-vide est nécessaire pour une utilisation optimale si un autre appareil sanitaire est raccordé sur la même évacuation.

Ne pas utiliser d'acide chlorhydrique ni de dégraissant puissant

Pose directe au sol

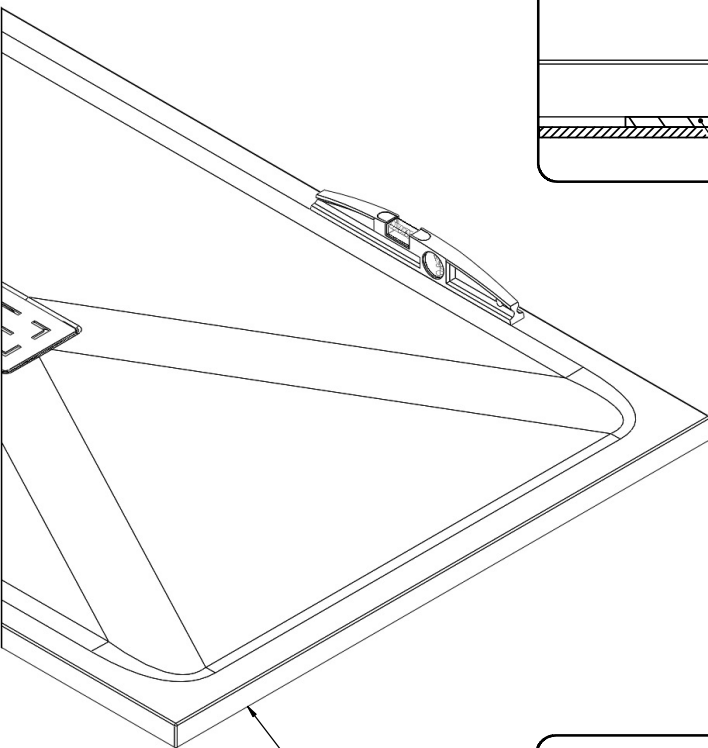
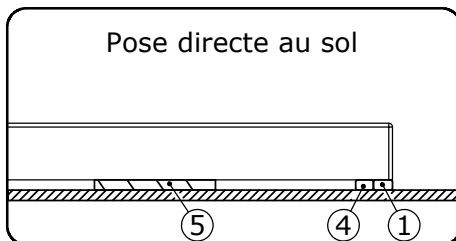

Sol rigide indispensable

En butée contre le carrelage

Carrelage  
5mm mini

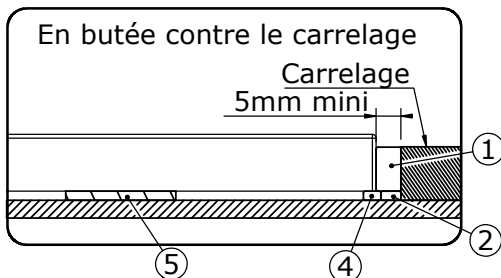

# KINEWOOD

## TYPES D'INSTALLATION

X	Y	B	C
90	70	20	30
100	80	25	35
120	80	25	45
140	80	25	55

### 1. Posé sur pieds réglables avec habillage carrelé

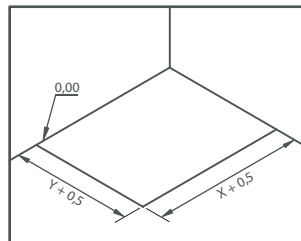
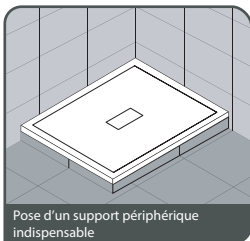

Préparation de l'implantation

### 2. Posé en butée contre le carrelage

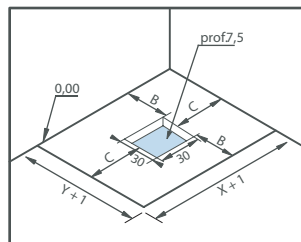
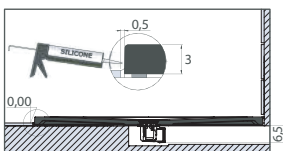
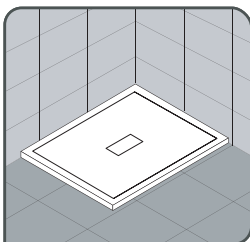

Préparation de l'implantation

### 3. Encastré et posé sur pieds réglables

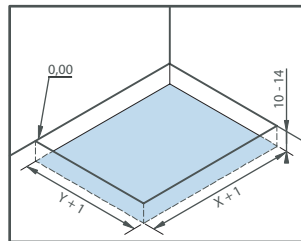
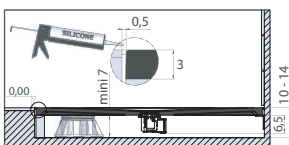
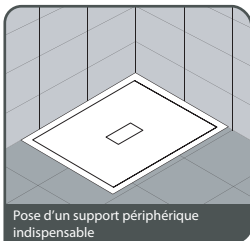

Préparation de l'implantation

### 4. Encastré et posé sans pieds réglables

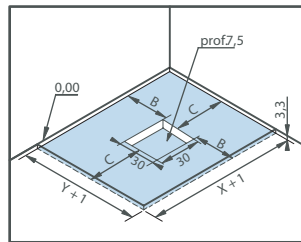
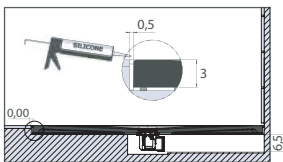
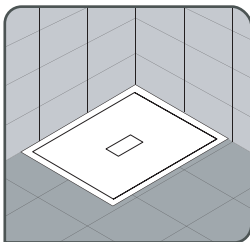

Préparation de l'implantation



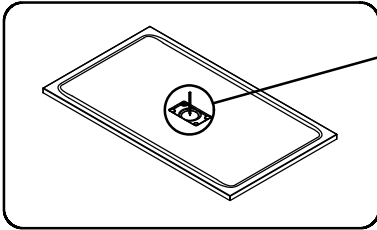

Mark the position of the waste and test-assemble the tray and waste

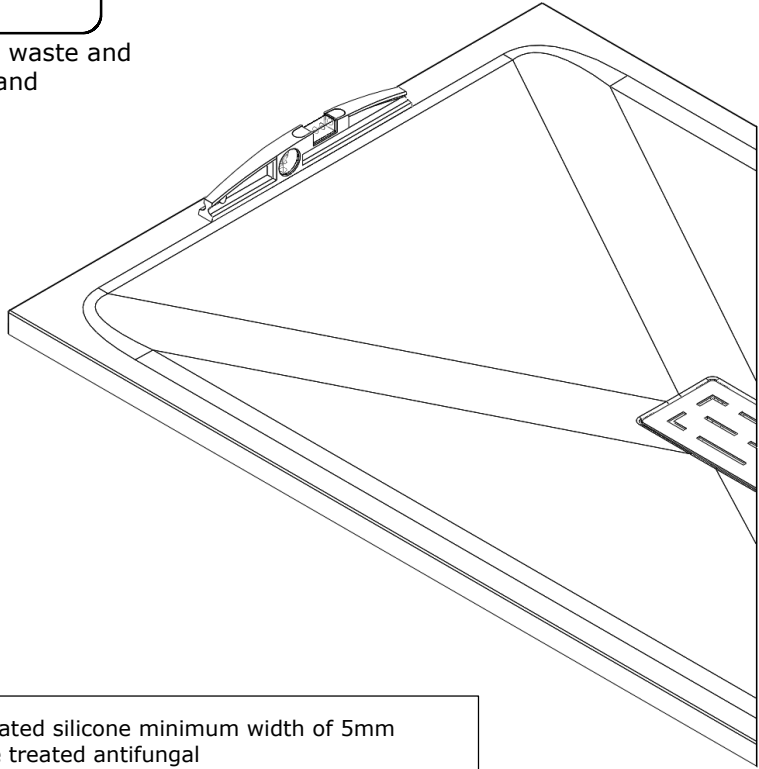

- ① - finishing antifungal treated silicone minimum width of 5mm
- ② - flexible sealing silicone treated antifungal
- ③ - support Element silicone seal
- ④ - silicone support
- ⑤ - polyurethane adhesive or MS polymer

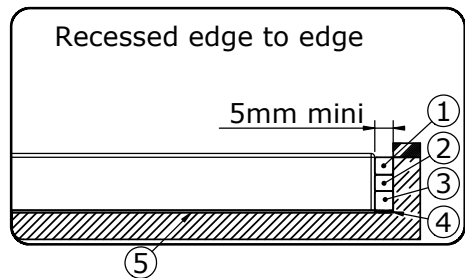
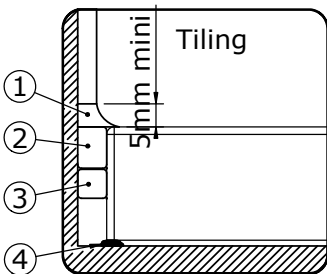





Throughout the protect the tray of the work, protect the recipient against any aggression: burns, shock, scratches, strppers...



Mounting a vacuum relief valve is required for use optimal if another fixture is connected to the same drain.

Do not use hydrochloric acid or powerful degreaser

### Direct floor installation

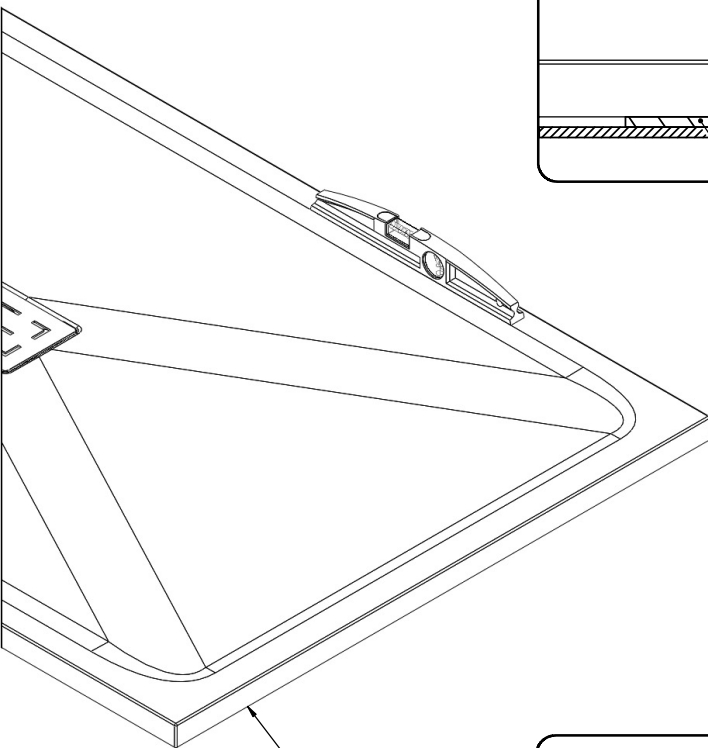
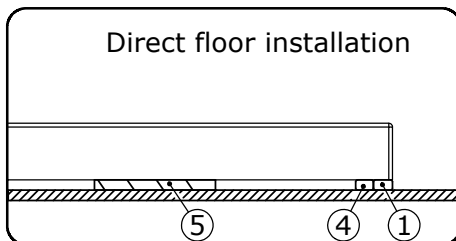

The base must be rigid, flat and dry

### Abutting against the tile

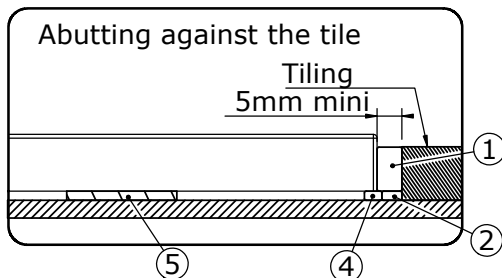

# KINEWOOD

## INSTALLATION TYPES

X	Y	B	C
90	70	20	30
100	80	25	35
120	80	25	45
140	80	25	55

### 1. Mounted on adjustable legs with tiled cladding

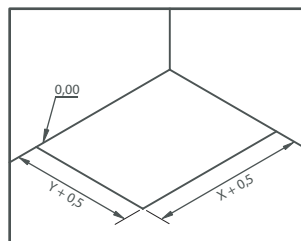
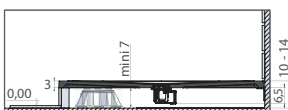

Pre-installation

### 2. Installed in abutment against the tile

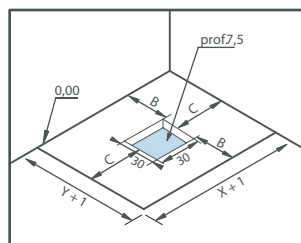
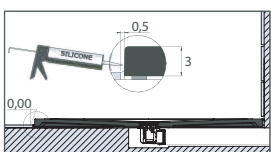
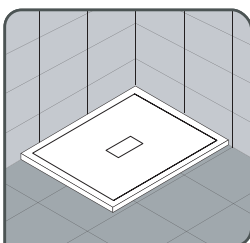

Pre-installation

### 3. Built-in and installed without adjustable feet

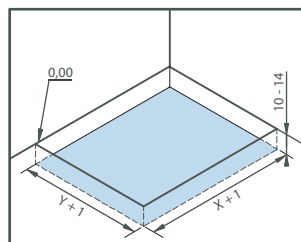
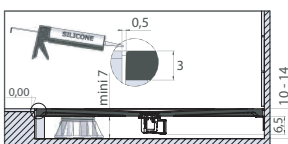

Pre-installation

### 4. Built-in and installed without adjustable feet

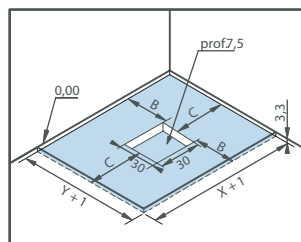
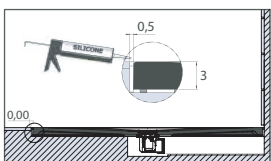
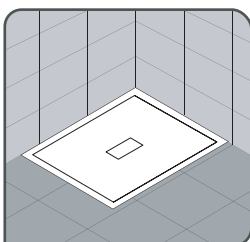

Pre-installation

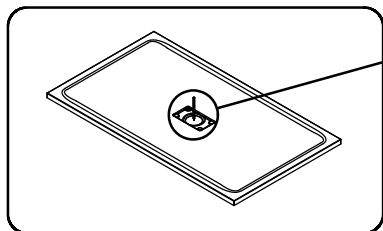

**E**

Marcar la ubicación del desagüe y montar el plato para comprobar su correcta ubicación.

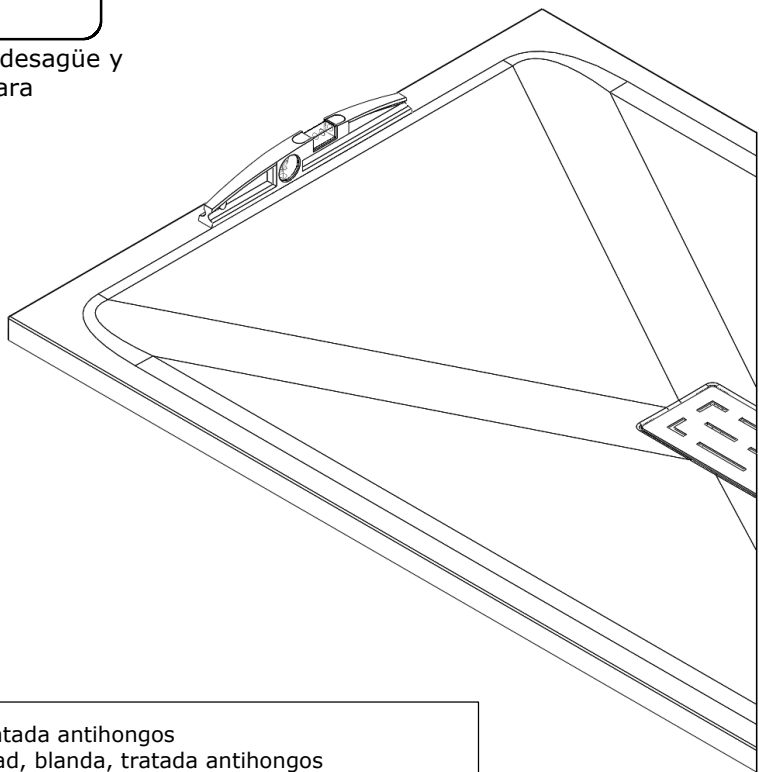

- ① - silicona de acabado tratada antihongos
- ② - silicona de estanqueidad, blanda, tratada antihongos
- ③ - soporte de la junta de silicona
- ④ - silicona de apoyo
- ⑤ - pegamento poliuretano o polímero MS

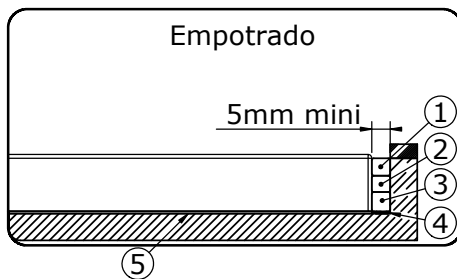
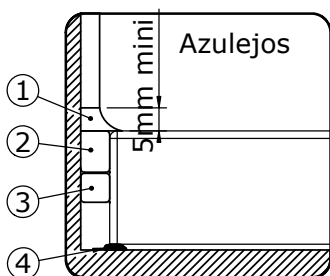



Durante las obras proteger el plato de golpes, quemaduras, rayaduras, etc...



La instalación de un veteo es necesaria si otro aparato está conectado al mismo recorrido de evacuación.

No utilizar ácido clorhídrico o desengrasante potente

Instalación directa al suelo

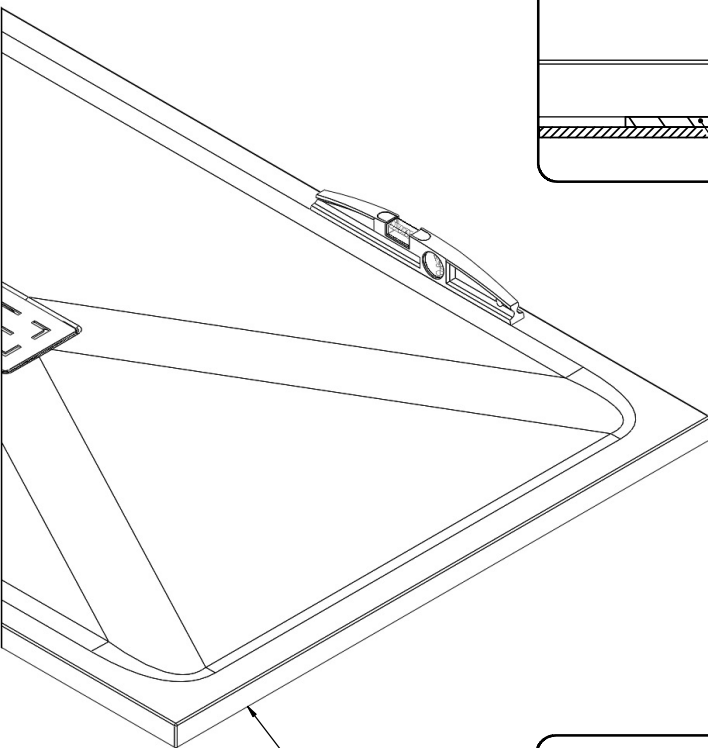
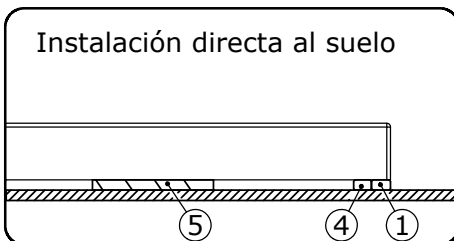

Suelo rígido, plano y seco indispensable

Instalación contra baldosas

Baldosas  
5mm mini

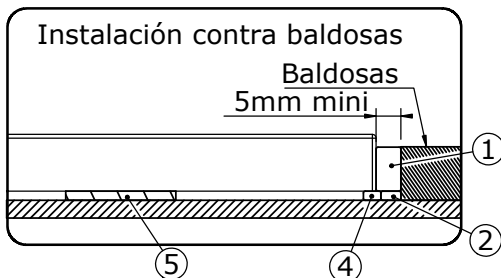

# KINEWOOD

## TIPOS DE INSTALACIÓN

X	Y	B	C
90	70	20	30
100	80	25	35
120	80	25	45
140	80	25	55

### 1. Instalado sobre pies regulables con revestimiento de baldosas

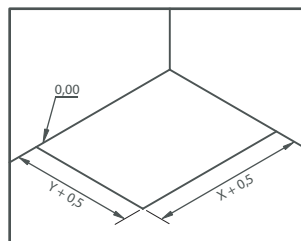
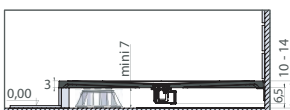

Preparación de la instalación

### 2. Instalación directa al suelo

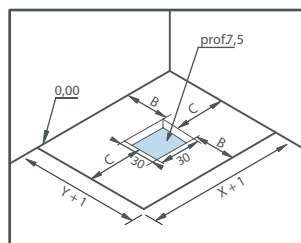
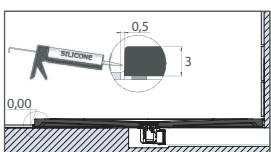
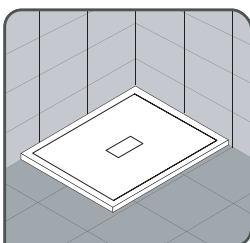

Preparación de la instalación

### 3. Instalación a ras de suelo, colocado sobre pies regulables

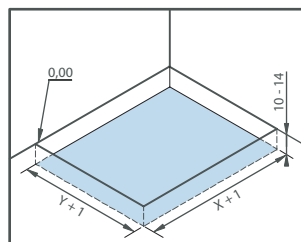
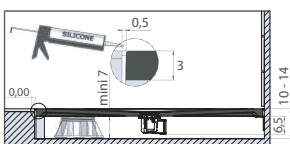

Preparación de la instalación

### 4. Instalación a ras de suelo, sin pies regulables

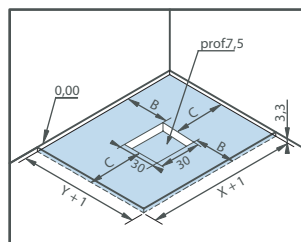
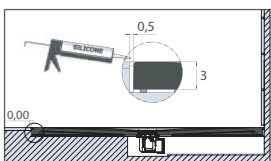
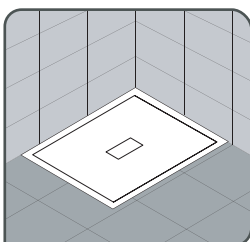

Preparación de la instalación



I

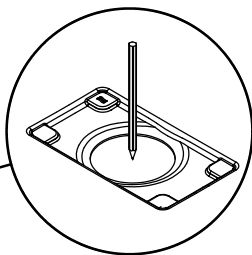
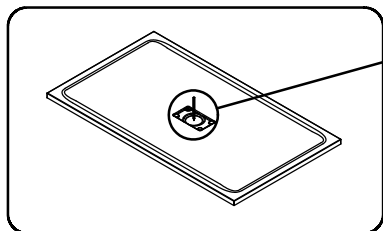

Tracciare la posizione dello scarico e realizzare un montaggio a vuoto dello scarico e del piatto

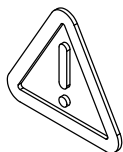
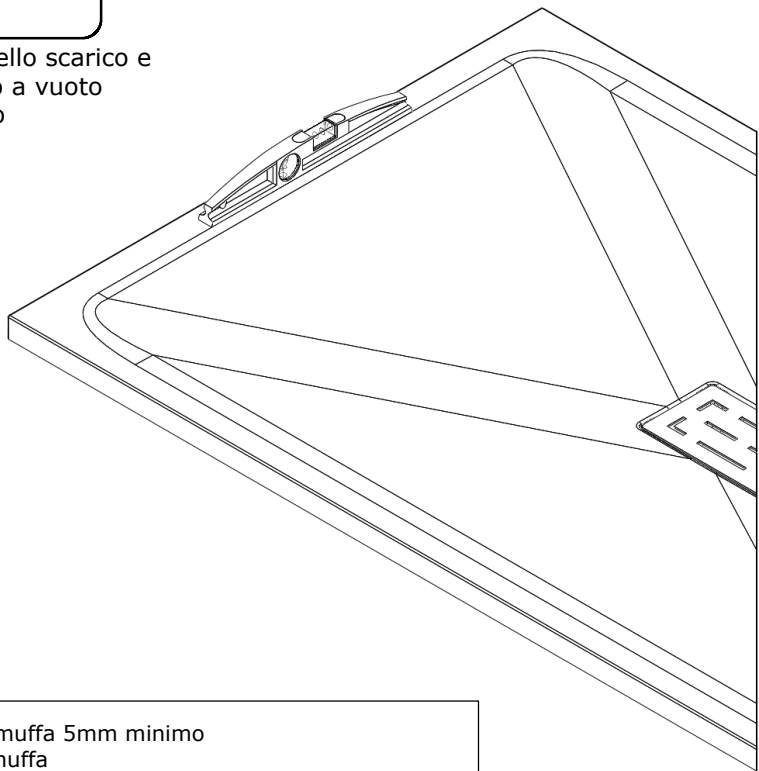

E essenziale avere un supporto inalterabile su tutti i lati del piatto

- ① - silicone di finitura antimuffa 5mm minimo
- ② - silicone di tenuta antimuffa
- ③ - elemento di tenuta del silicone
- ④ - supporte in silicone
- ⑤ - colla poliuretanica o MS polimero

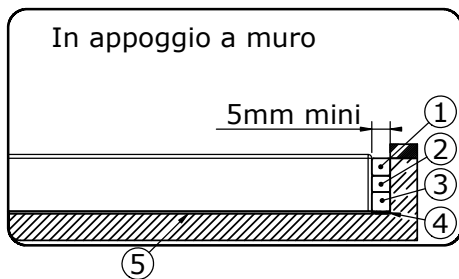
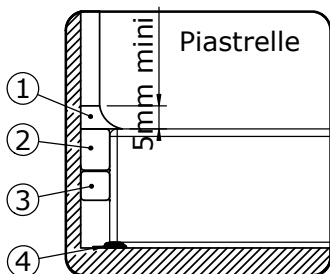





Durante la posa proteggere il piatto da graffi, colpi, attrezzi, bruciature ...



Il montaggio di una valvola di sicurezza è richiesto per un uso ottimale se un'altre utenze sono collegate allo stesso scarico.

Non utilizzare acido cloridrico o forti sgrassatori

Posa diretta al suolo

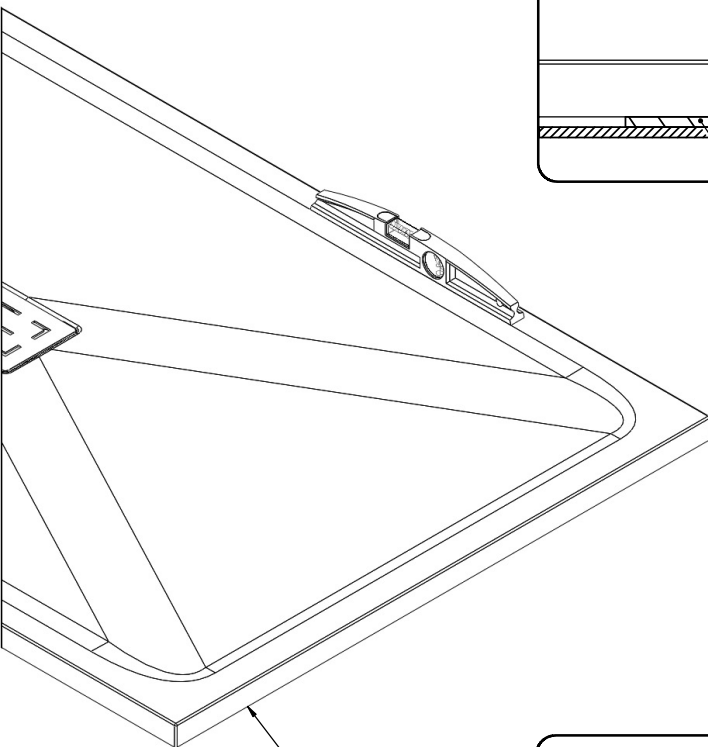
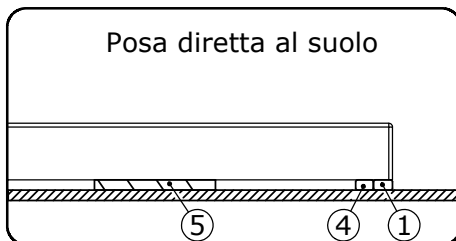

Suolo robusto e non umido

Battuta contro la piastrella  
piastrella  
5mm mini

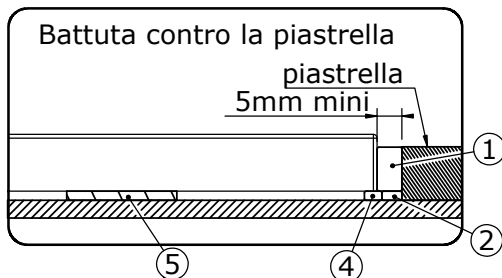

# KINEWOOD

## TIPI DI INSTALLAZIONE

X	Y	B	C
90	70	20	30
100	80	25	35
120	80	25	45
140	80	25	55

### 1. Montato su piedini regolabili con rivestimento in piastrelle

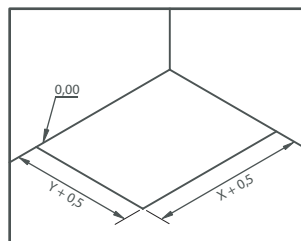
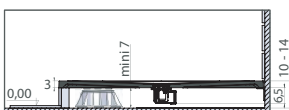

Predisposizione impianto

### 2. Installato in appoggio a pavimento

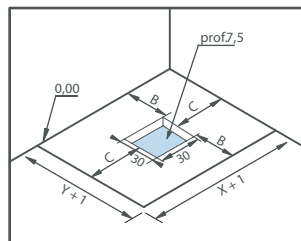
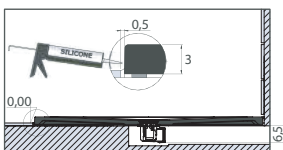
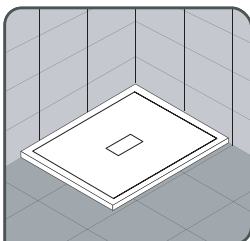

Predisposizione impianto

### 3. Incassato e posizionato su piedini regolabili

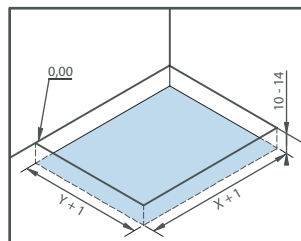
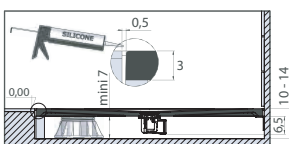

Predisposizione impianto

### 4. Installato a filo pavimento

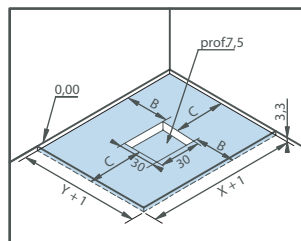
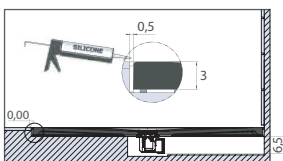
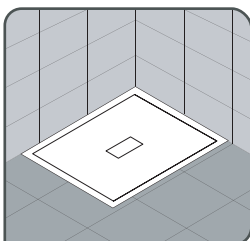

Predisposizione impianto



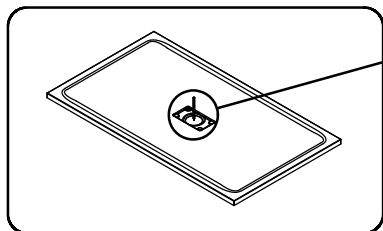

Markeer de positie van de afvoer en  
situeer de afvoer en de douchebak  
op de gewenste plaats

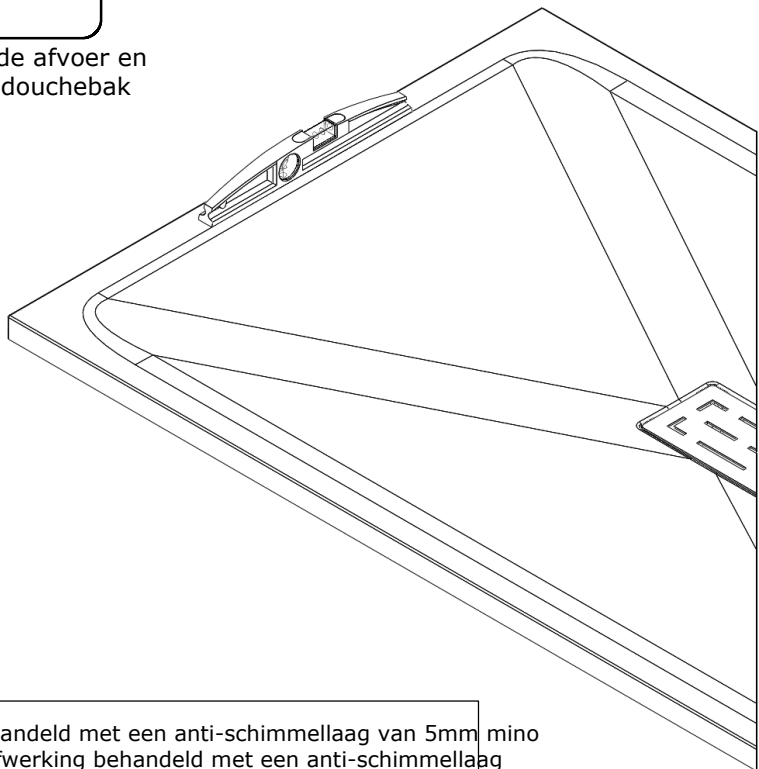

- ① - siliconanafwerking behandeld met een anti-schimmellaag van 5mm mino
- ② - waterdichte siliconanafwerking behandeld met een anti-schimmellaag
- ③ - element ter ondersteuning van de siliconenstrip
- ④ - aanbrengen van siliconenkit
- ⑤ - polyurethaan lijm of MS ployleer

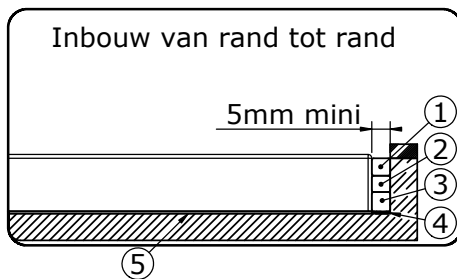
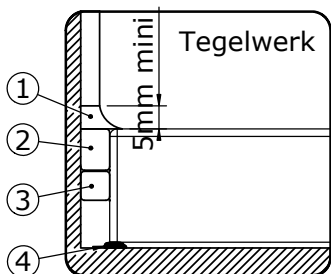



Bescherm de douchebak tijdens de werkzaamheden tegen brandplekken, schokken en beschadigingen door krassen etc...



De Montage van een afdichtingsklep/ventiel is noodzakelijk voor optimaal gebruik indien men een ander sanitair product wil aansluiten op d dezelfde afvoer.

Geen chloorhoudende producten en ontvetters gebruiken!

Plaatsing direct op de vloer

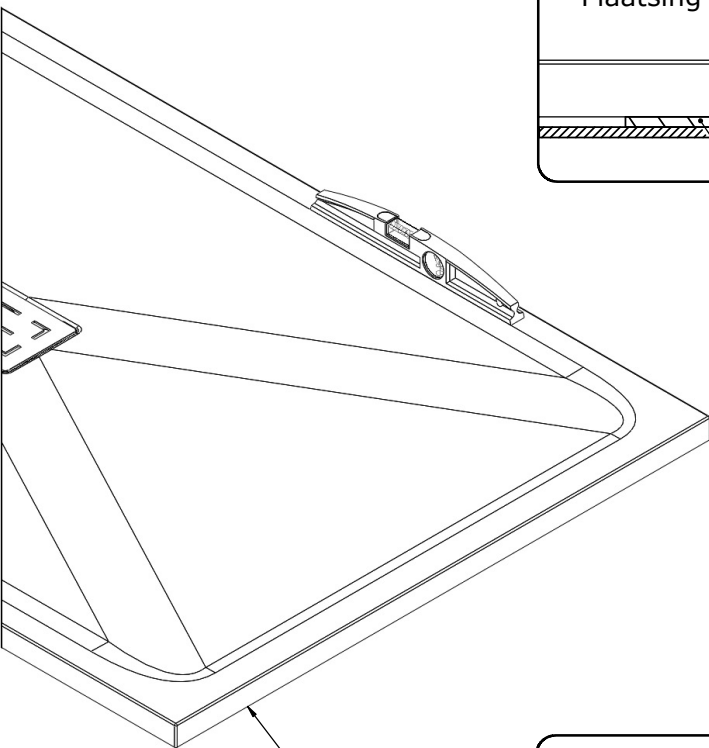
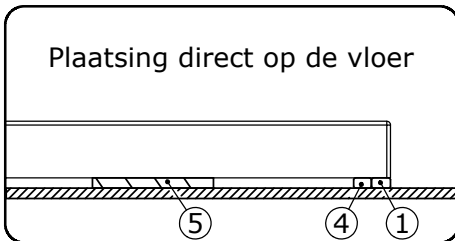

Vlakke niet-vochtige vloer is essentieel

Plaatsing tegen het tegelwerk

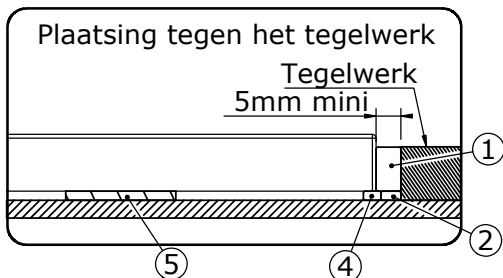

# KINEWOOD

## INSTALLATIEMOGELIJKHEDEN

X	Y	B	C
90	70	20	30
100	80	25	35
120	80	25	45
140	80	25	55

### 1. Geïnstalleerd op in hoogte verstelbare poten en afgewerkt met tegels

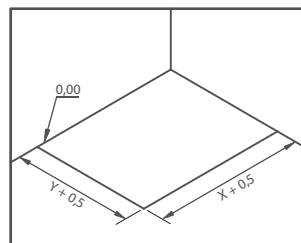
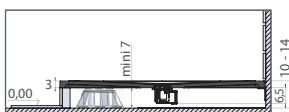

Vorbereitung montage

### 2. Geïnstalleerd gedeeltelijk verzonken op tegels

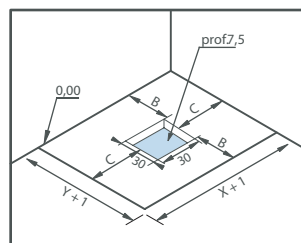
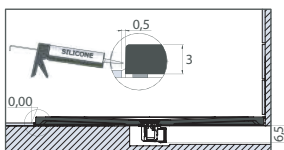
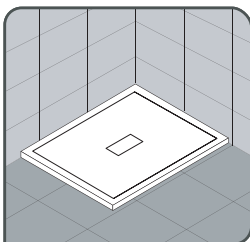

Vorbereitung montage

### 3. Ingebouwd met in hoogte verstelbare poten

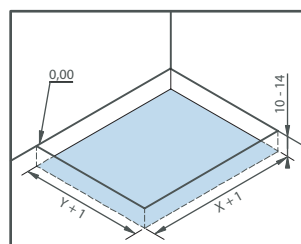
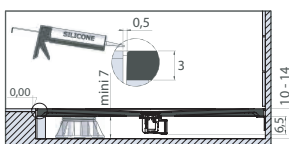

Vorbereitung montage

### 4. Ingebouwd zonder in hoogte verstelbare poten

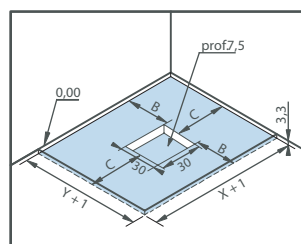
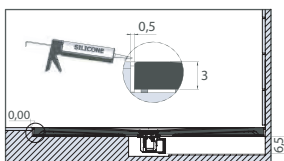
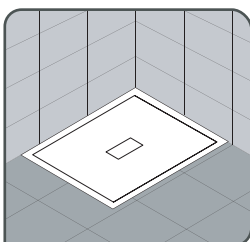

Vorbereitung montage

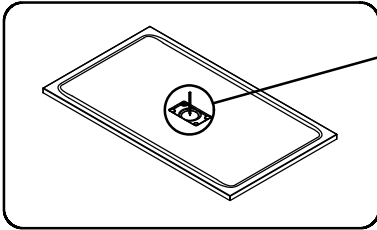

**D**

Position für den Ablauf anzeichnen  
und vormontieren.

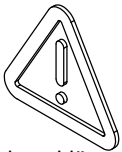
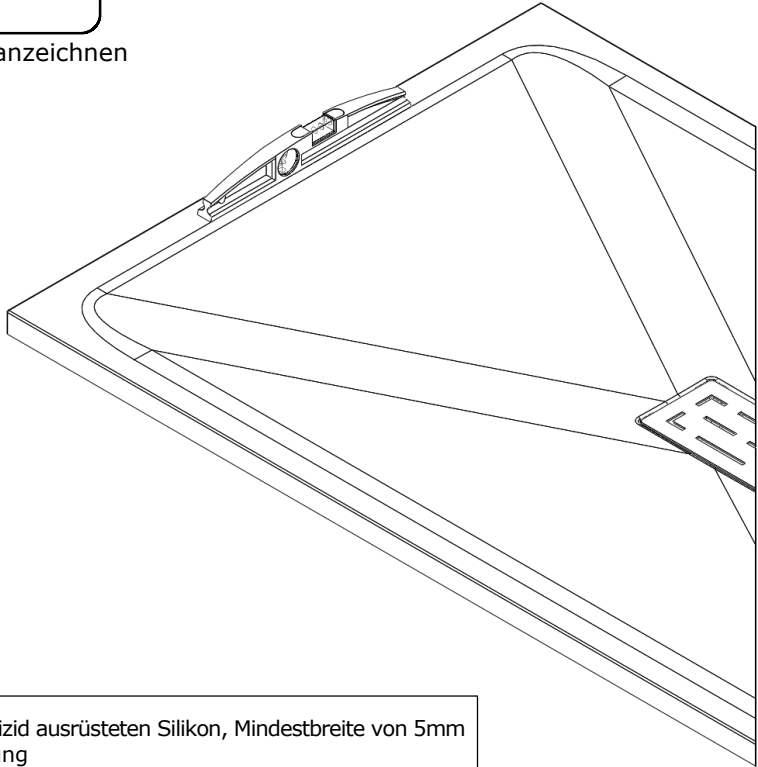

Wandanschlüsse  
umlaufend mit  
Wannenrandabdichtu  
bg versehen.

- ① - Fugenabschluss mit fungizid ausgerüsteten Silikon, Mindestbreite von 5mm
- ② - flexible Silikonabdichtung
- ③ - Träger Element/Unterbau Silikondichtung
- ④ - Silikonträger
- ⑤ - Polyurethan-Klebstoff oder MS-Polymer

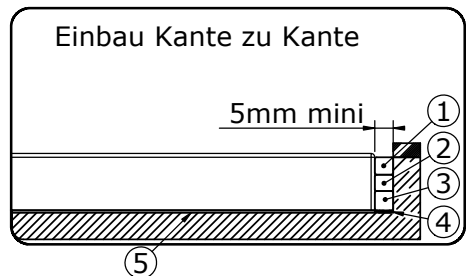
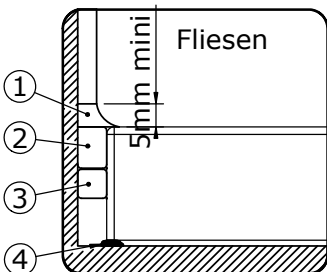





Montage eines Unterdruckventils wird benötigt, wenn eine andere Vorrichtung an den gleichen Ablauf angeschlossen ist.

Während den Installationsarbeiten auf ausreichenden Schutz gegen aggressive Mittel achten: Verbrennungen, Stöße, Kratzer oder Abbeizmittel...

Verwenden Sie keine säurehaltigen oder andere aggressive Entfetter.

freie Aufstellung auf Fertigfußboden

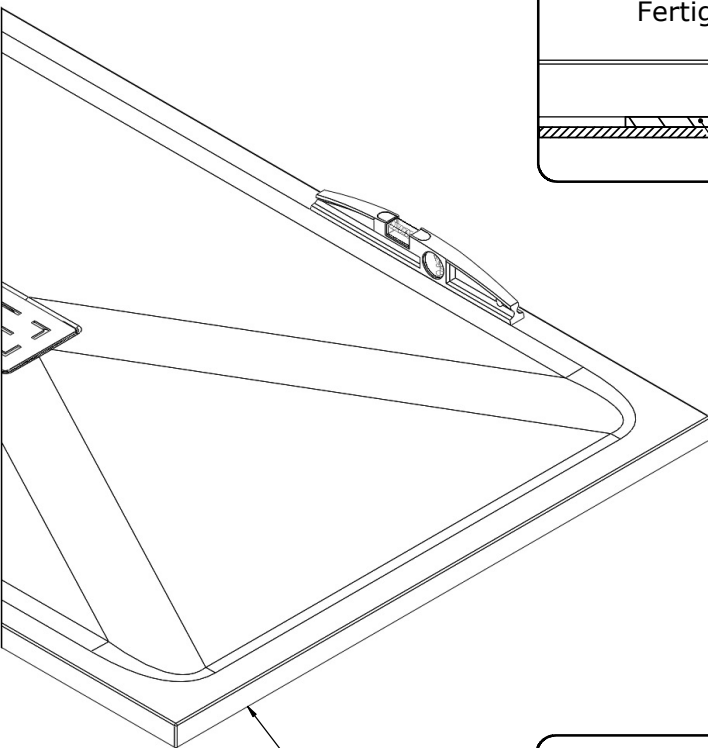
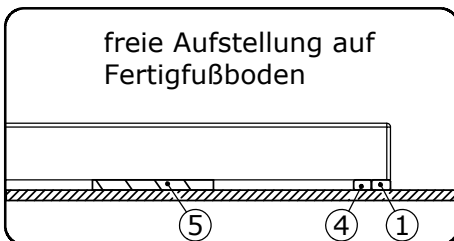

Auf festen, planen und nicht feuchten Boden achten.

einseitiger Wannenanschluß

Fliesen  
5mm mini

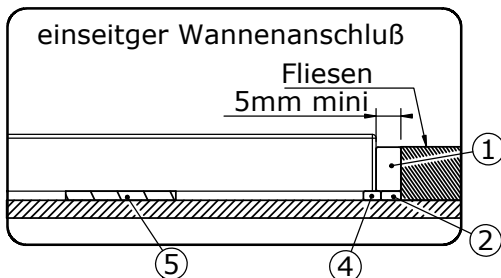

# KINEWOOD

## INSTALLATIONSARTEN

X	Y	B	C
90	70	20	30
100	80	25	35
120	80	25	45
140	80	25	55

### 1. Montage auf Fertigfußboden mit Wannenfüßen und Fliesensockel

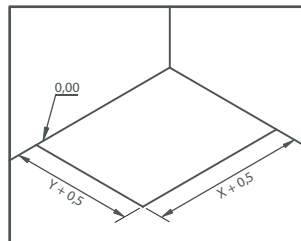
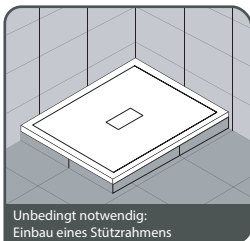

Montagevorbereitung entfällt

### 2. Montage auf fliesenboden aufliegend

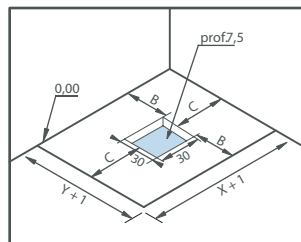
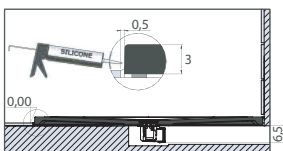
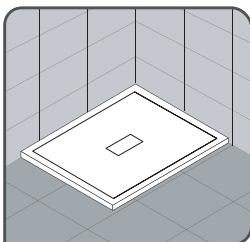

Montagevorbereitung entfällt

### 3. Bodengleiche Montage mit Wannenfüße

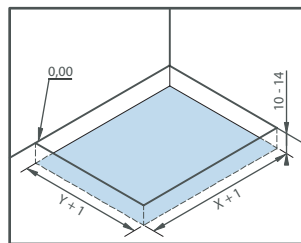
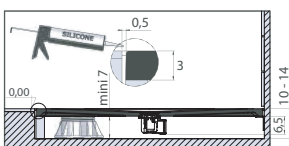
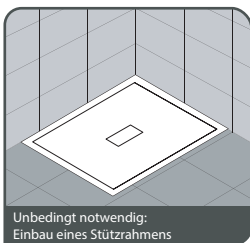

Montagevorbereitung entfällt

### 4. Bodengleiche Montage ohne Wannenfüße

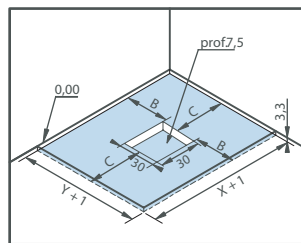
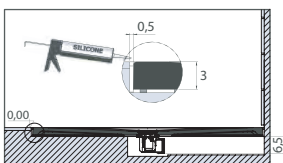
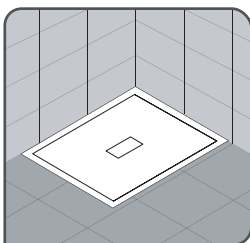

Montagevorbereitung entfällt

- F Mise en place des plots de colle polyuréthane ou MS polymère
  - GB Loading the plots glue polyurethane or MS polymer
- E Ubicacion de los puntos de pegamento poliuretano o polimero MS
  - I Posizione dei punti di colla poliuretanicica o MS polimero
- NL Breng de polyurethaan lijm of MS polymeer aan op de juiste plaats
  - D Bringen Sie den Polyurethan-/MS-Polymere-Kleber auf

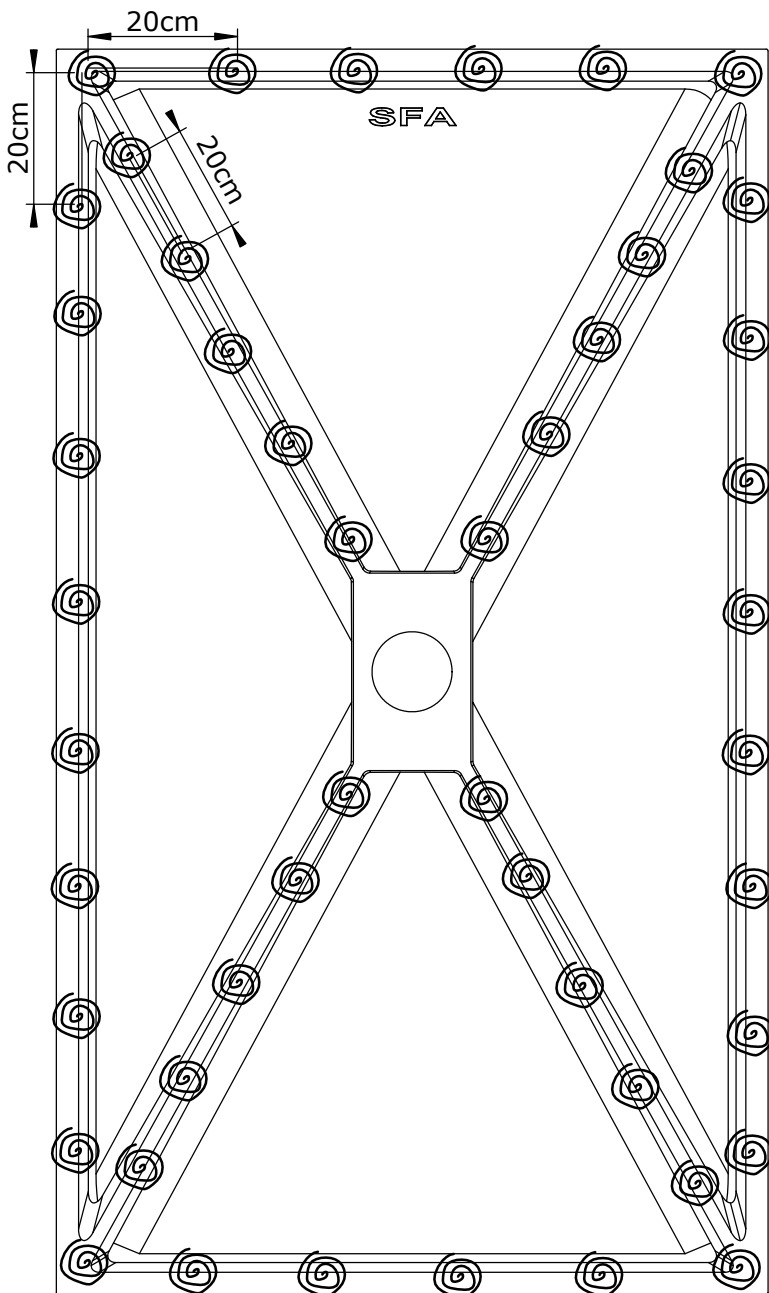



24h

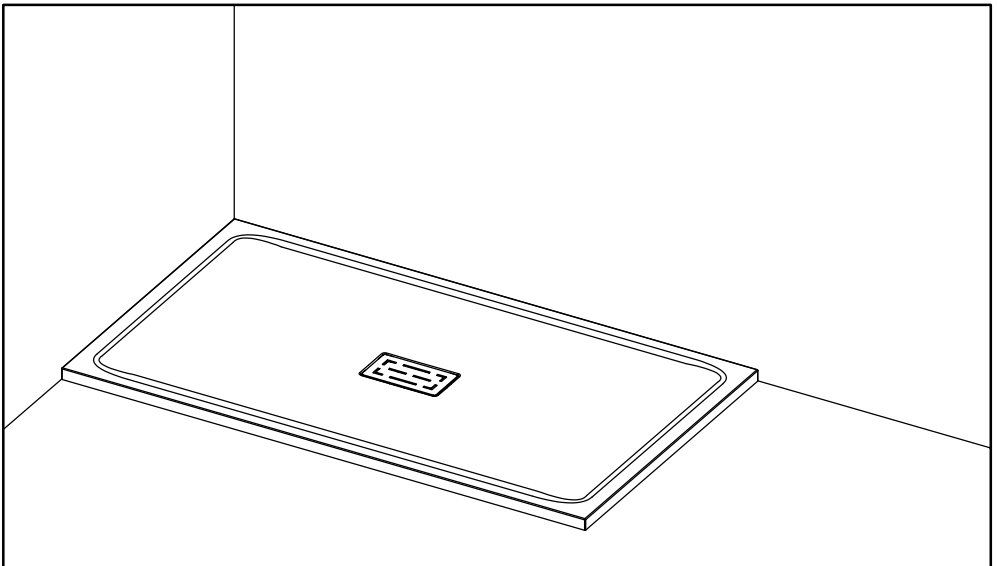







AQUAPRODUCTION, Site industriel,  
F - 44680 Chaumes-en-Retz

20

**EN 14527 - CL2**

Aptitude au nettoyage : satisfaisant

Durabilité : satisfaisant



## SERVICE APRÈS-VENTE AFTER-SALES SERVICE

### FRANCE

+33 (0)2 40 21 29 45

### UK

+44 (0)20 8842 0033

### IRELAND

+353 04697 33102

### DEUTSCHLAND

+49 (0) 6074 / 30928 0

### ITALIA

+39 (0382) 6181

### ÖSTEREICH

+43 1 710 60 70

### SUISSE/SCHWEIZ

+41 (0)32 631 04 74

### ESPAÑA

+34 93 544 60 76

### NEDERLAND

+31 475 487 100

### BELGIQUE/BELGIË

+31 475 487 100

### РОССИЯ

+7 495 258-29-51

### PORTUGAL

+351 219 112 785